

Study Guide Test 8 Graphing

State if the polygons are similar.

1)

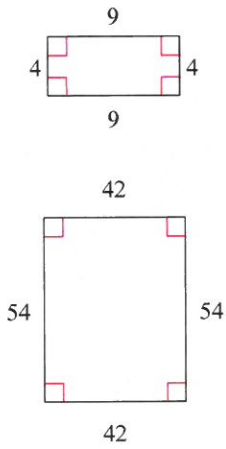

2)

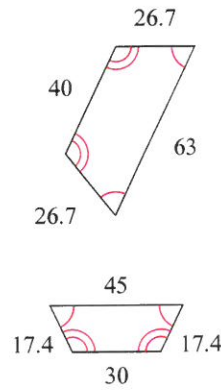

3)

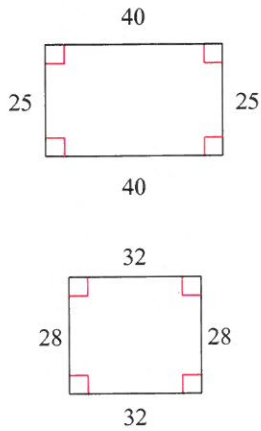

4)

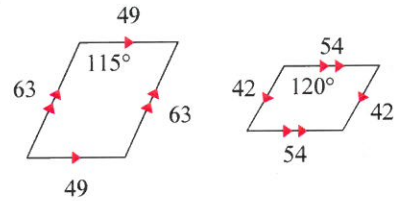

5)

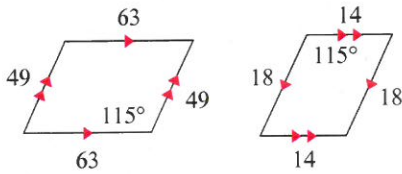

6)

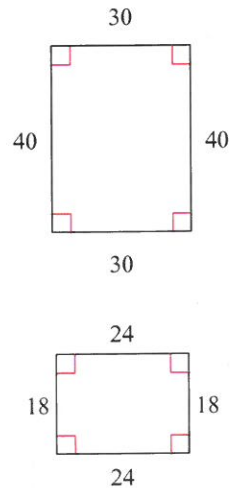

7)

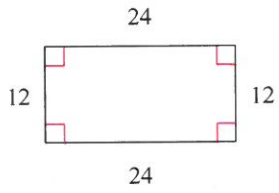
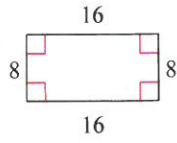

8)

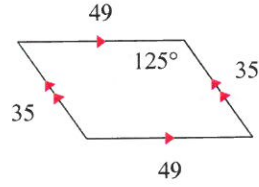
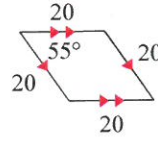

9)

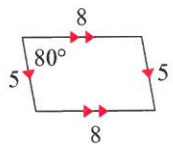
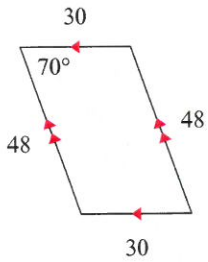

10)

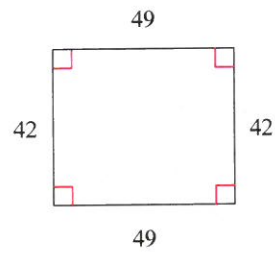
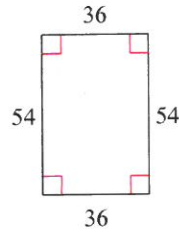

The polygons in each pair are similar. Find the missing side length.

11)

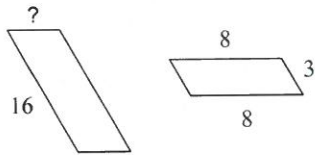

12)

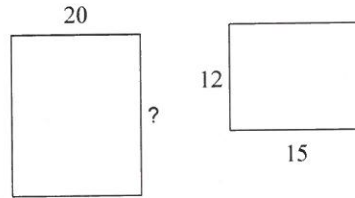

13)

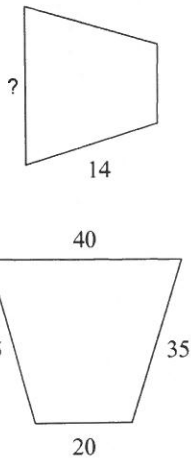

14)

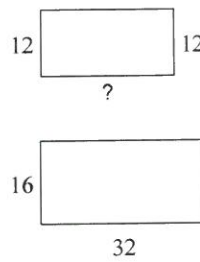

15)

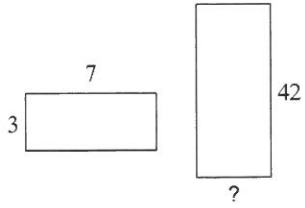

16)

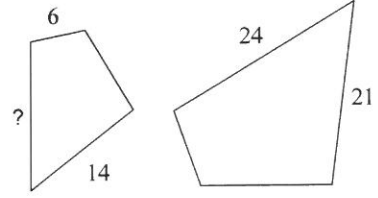

17)

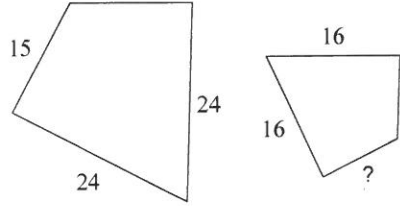

18)

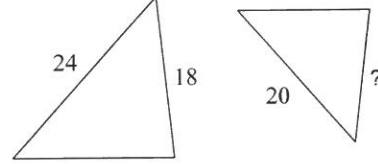

19)

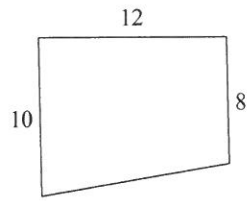

20)

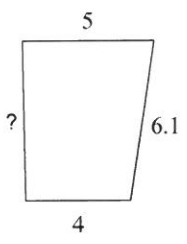
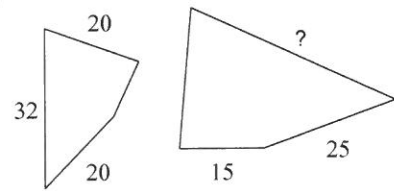

21)

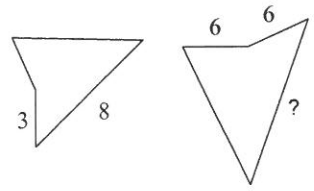

22)

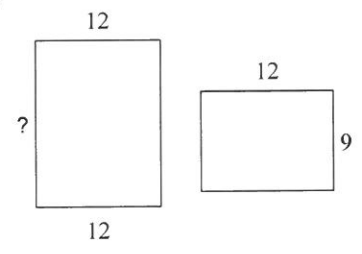

23)

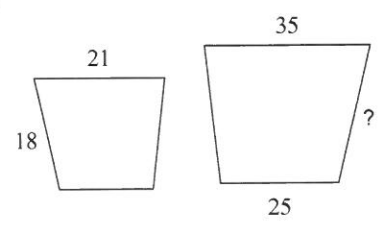

24)

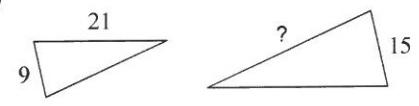

25)

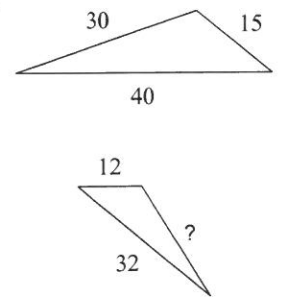

26)

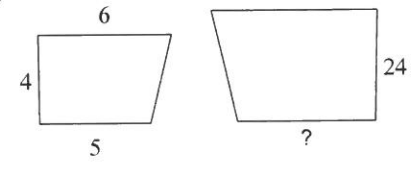

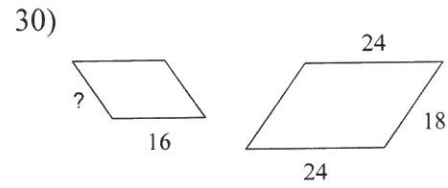
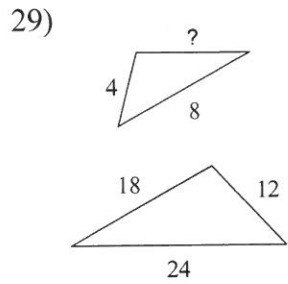
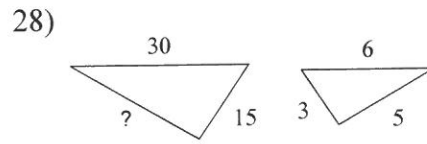
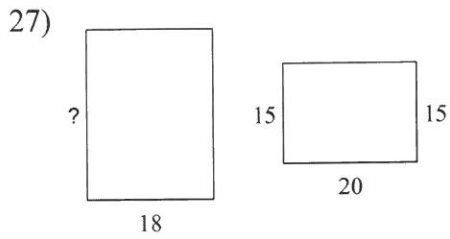

State if the triangles in each pair are similar.

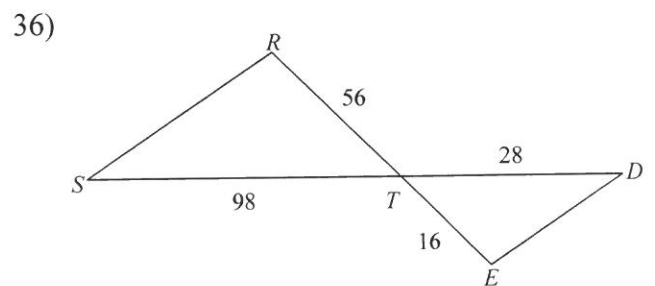
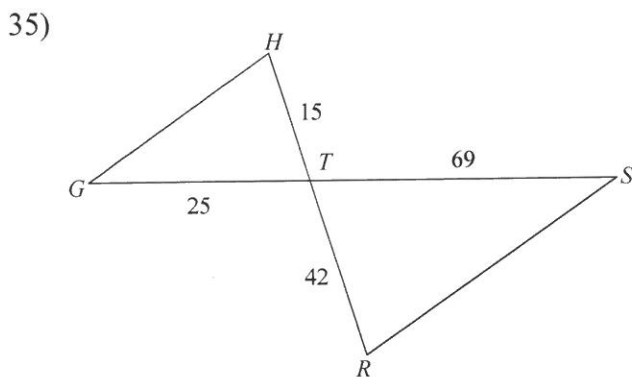
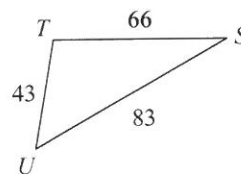
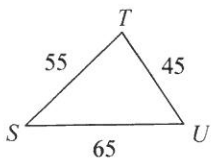
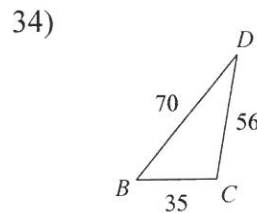
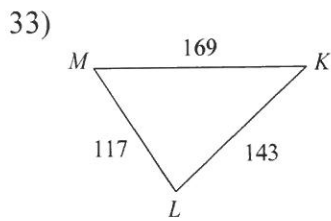
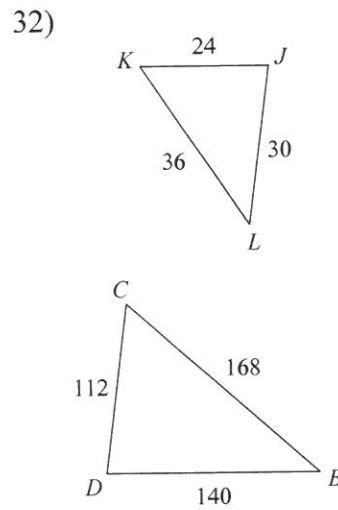
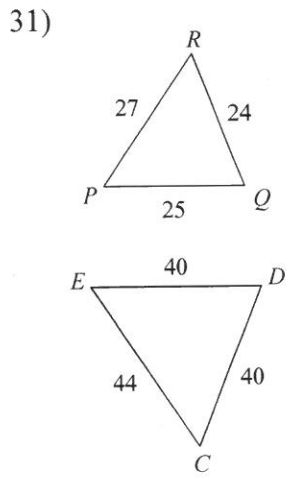

37)

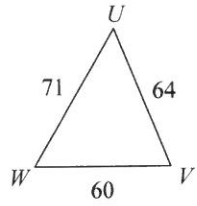
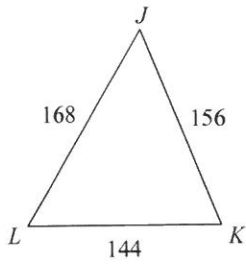

38)

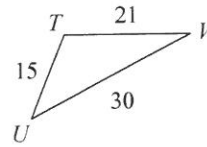
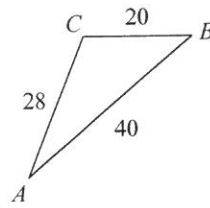

39)

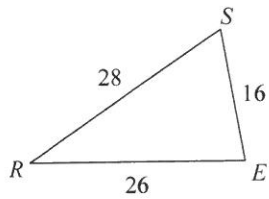
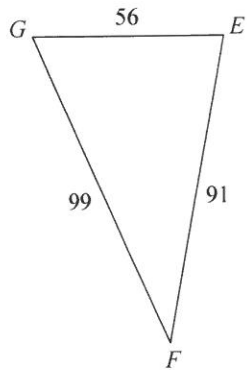

40)

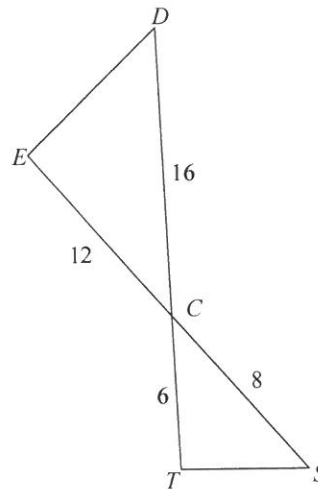

Find the missing length. The triangles in each pair are similar.

41)

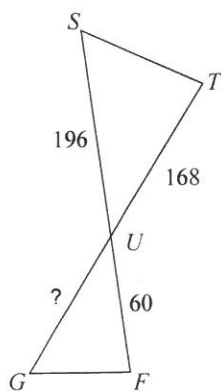

42)

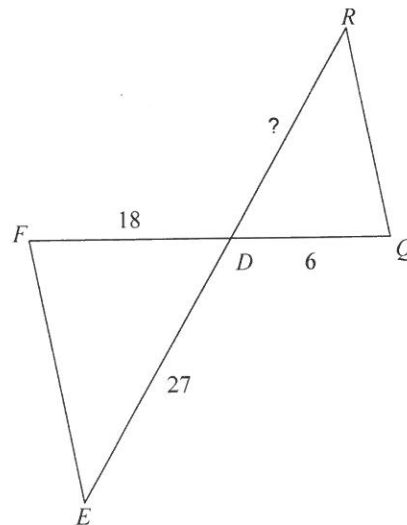

43)

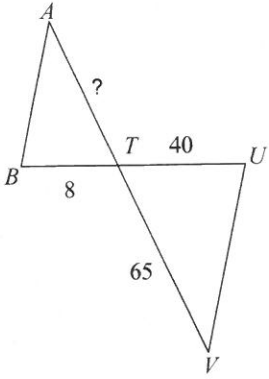

44)

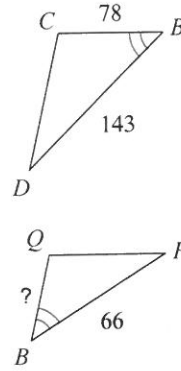

45)

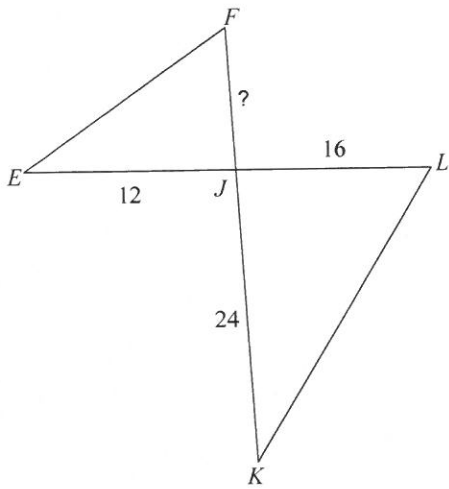

46)

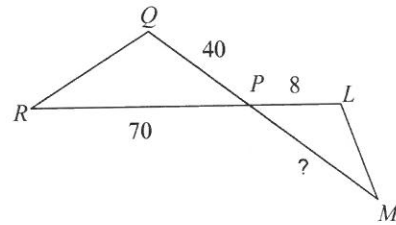

47)

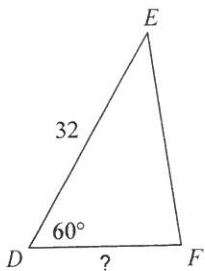
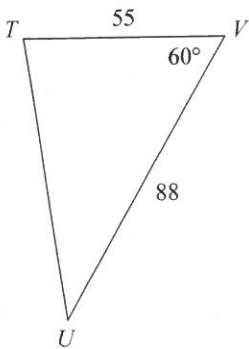

48)

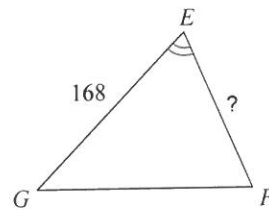
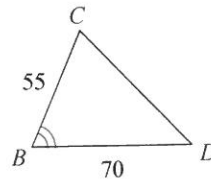

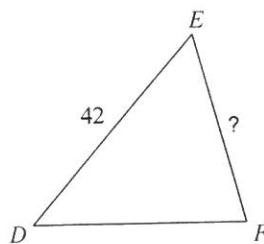
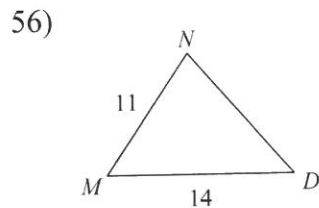
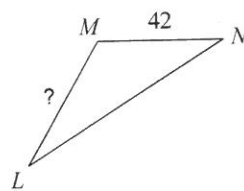
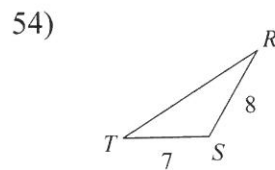
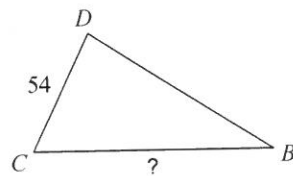
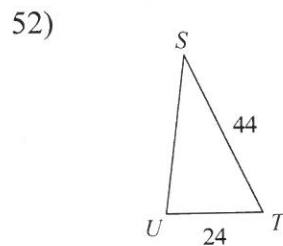
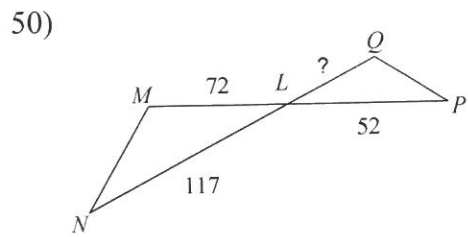
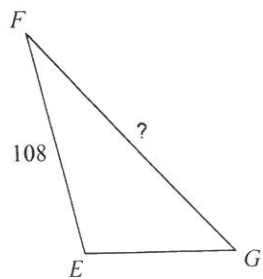
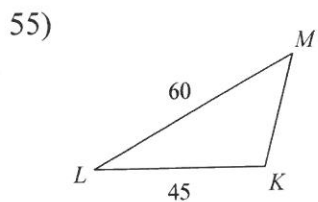
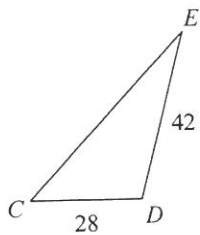
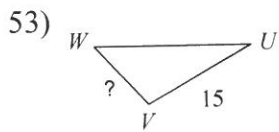
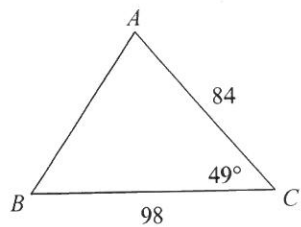
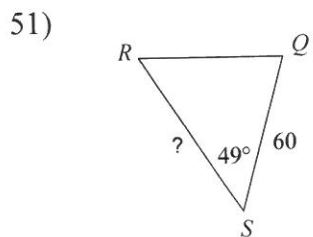
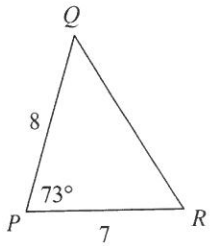
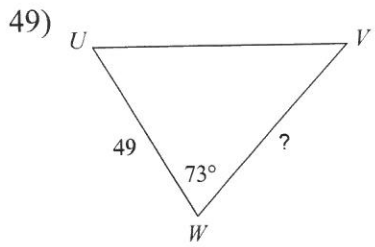

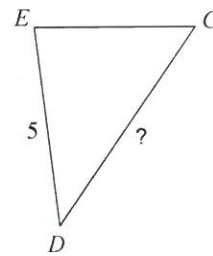
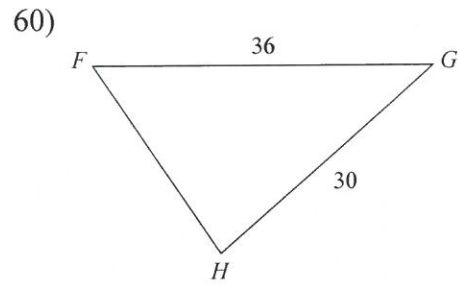
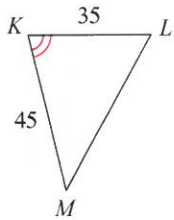
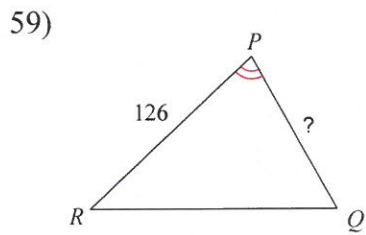
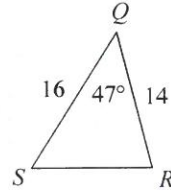
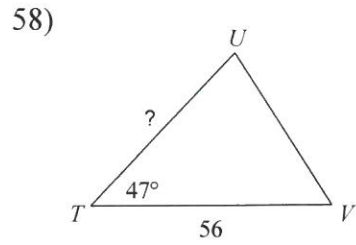
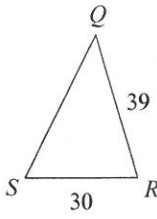
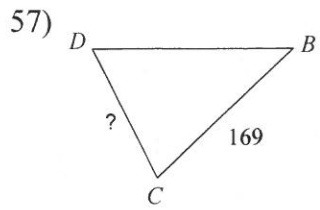

State the coordinates of each point.

61)

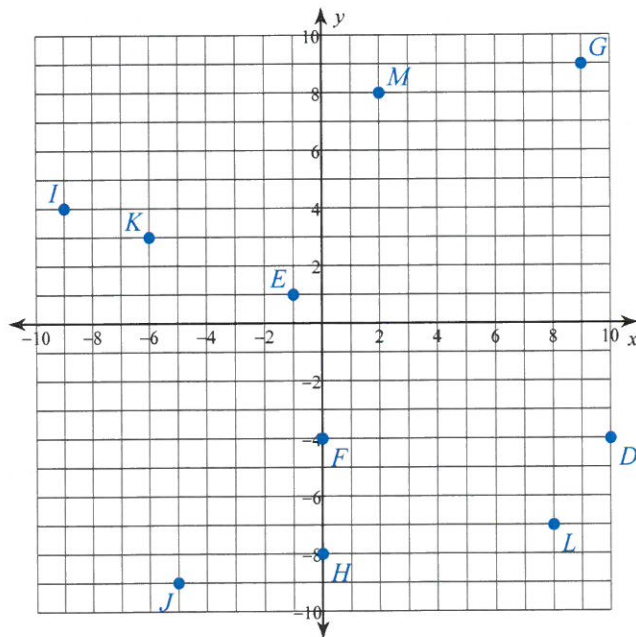

62)

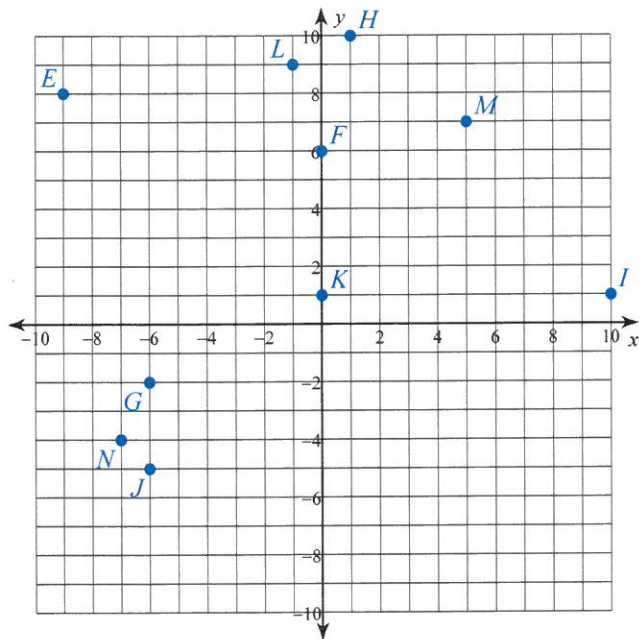

63)

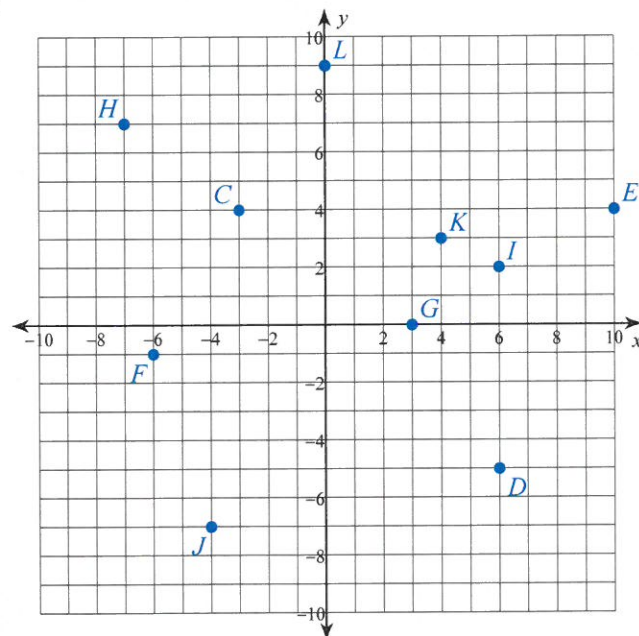

64)

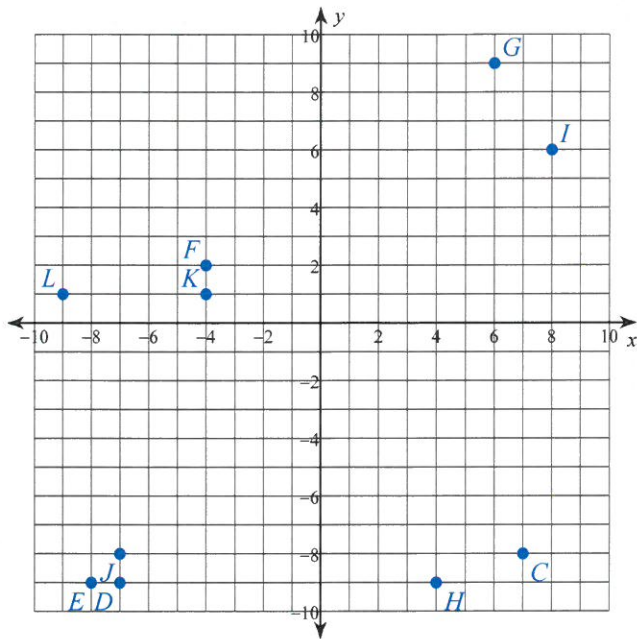

65)

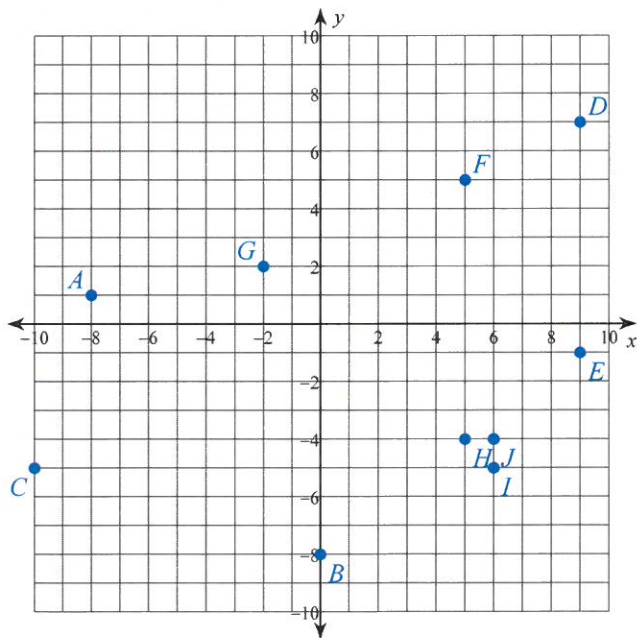

Plot each point.

- 66) $D(-2, -6)$ $E(10, 5)$ $F(0, -6)$
 $G(-3, -4)$ $H(6, 9)$ $I(-7, -7)$
 $J(-7, -5)$ $K(6, 5)$ $L(-3, 2)$
 $M(7, 8)$

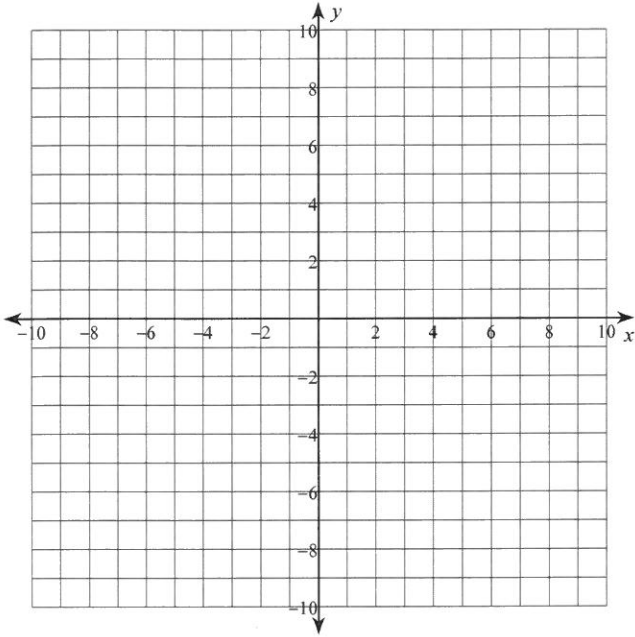

- 67) $A(6, -7)$ $B(1, 6)$ $C(-10, -4)$
 $D(-8, 3)$ $E(0, 1)$ $F(-8, -6)$
 $G(7, 10)$ $H(0, 9)$ $I(9, -3)$
 $J(4, -6)$

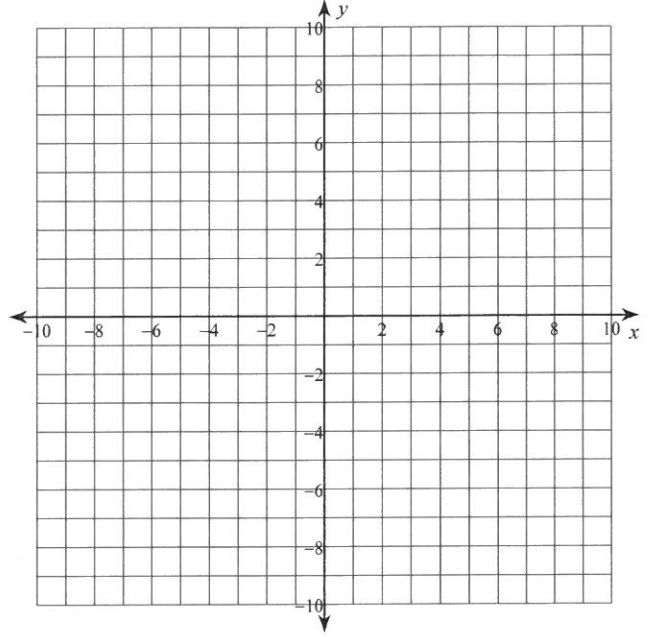

- 68) $B(-6, 9)$ $C(-4, 5)$ $D(-2, -2)$
 $E(6, 3)$ $F(-8, -5)$ $G(3, 8)$
 $H(-8, -4)$ $I(-8, 8)$ $J(4, -8)$
 $K(-4, 1)$

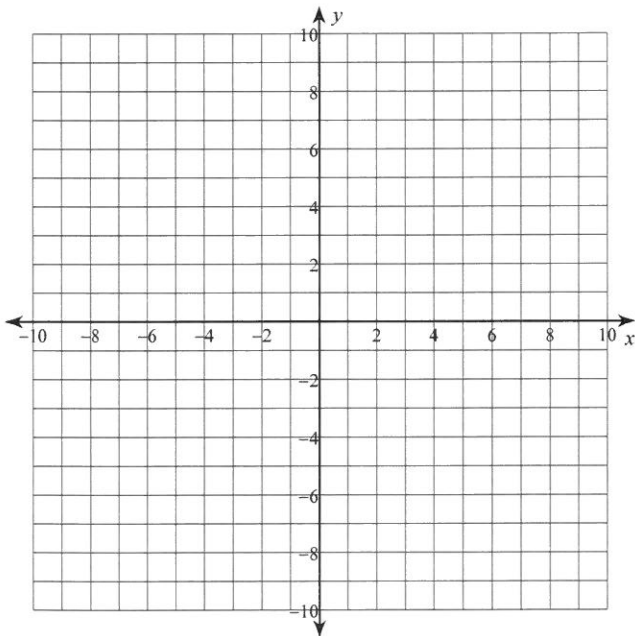

- 69) $M(2, 2)$ $L(-2, 4)$ $K(9, 7)$
 $J(6, 3)$ $I(0, 3)$ $H(10, 5)$
 $G(-8, 5)$ $F(5, 0)$ $E(-1, 7)$
 $D(-10, 8)$

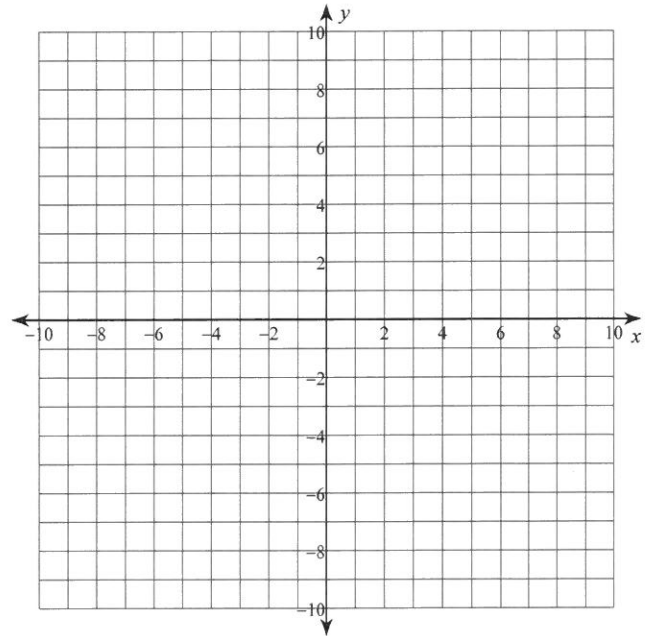

- 70) $D(-2, 8)$ $E(9, 5)$ $F(-3, 10)$
 $G(-1, -1)$ $H(4, 5)$ $I(-10, 5)$
 $J(7, -2)$ $K(6, -4)$ $L(1, 9)$
 $M(5, -4)$

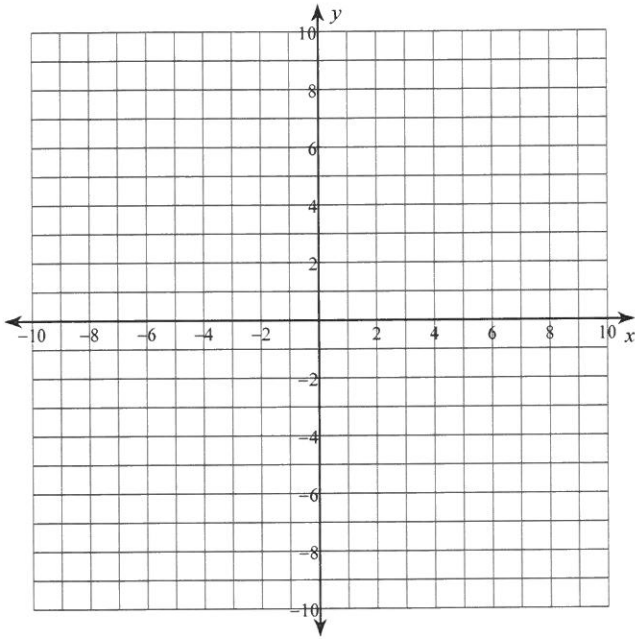

Graph the image of the figure using the transformation given.

- 71) rotation 90° clockwise about the origin

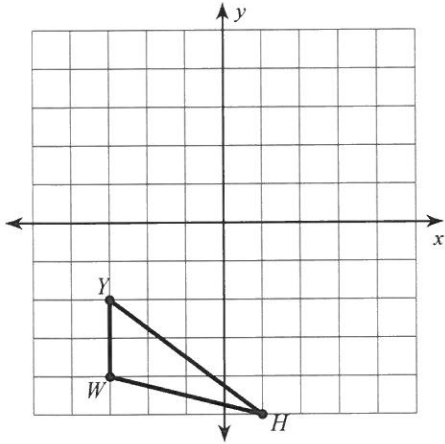

- 72) reflection across the x-axis

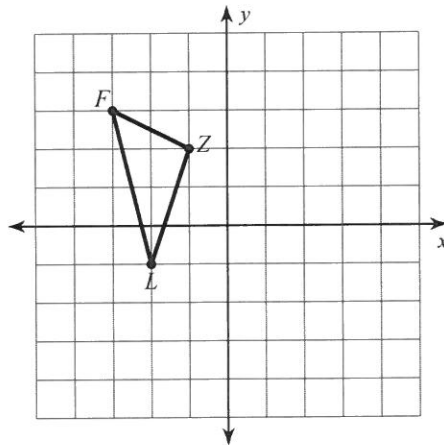

- 73) rotation 180° about the origin

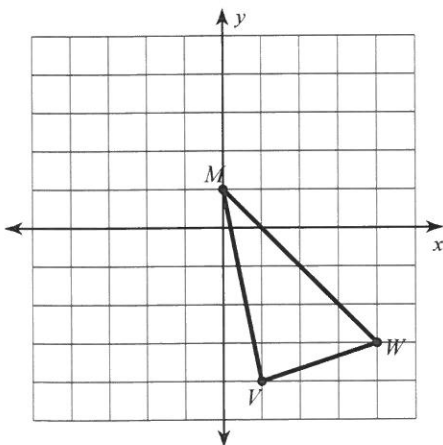

- 74) rotation 180° about the origin

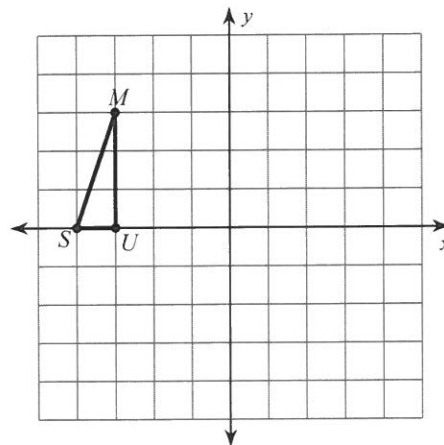

75) reflection across the y-axis

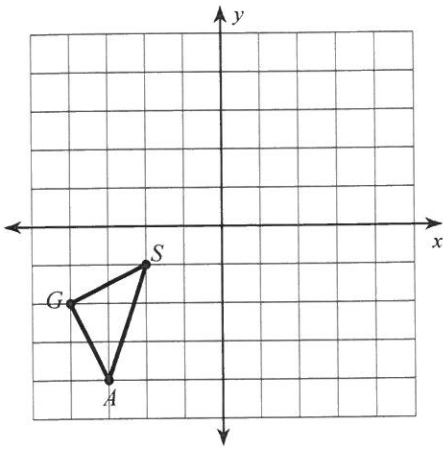

76) rotation 90° clockwise about the origin

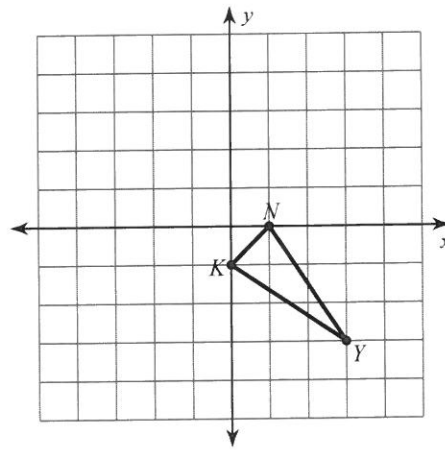

77) reflection across the x-axis

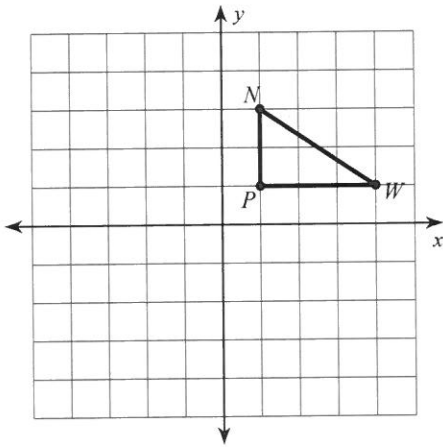

78) translation: 2 units down

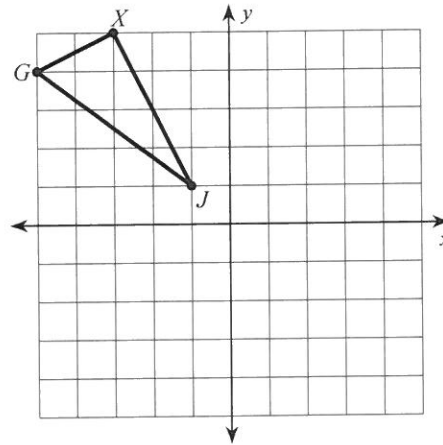

79) translation: 1 unit right and 2 units up

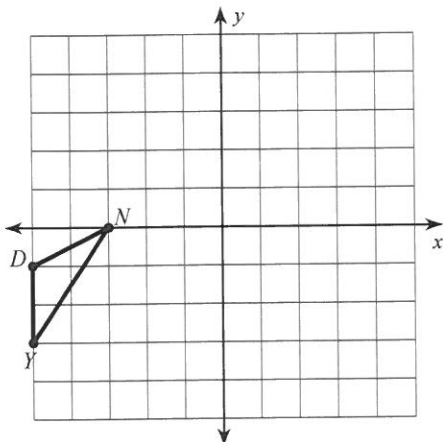

80) reflection across the y-axis

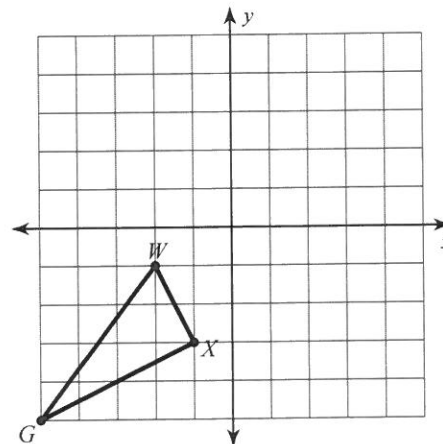

81) translation: 1 unit right and 4 units down

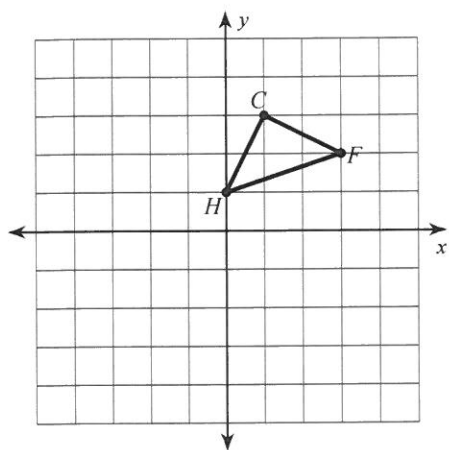

82) translation: 7 units left

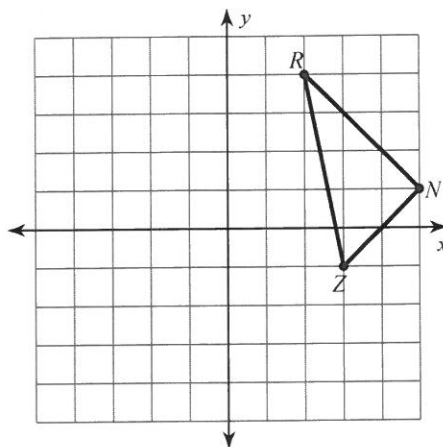

83) reflection across the x-axis

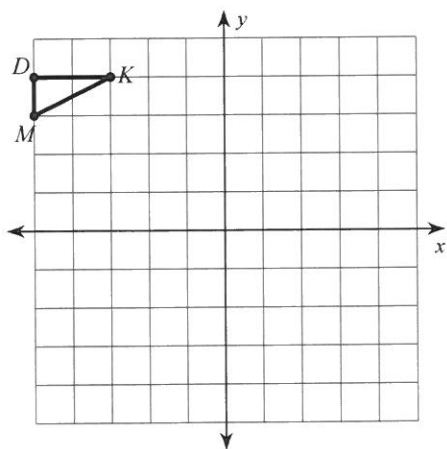

84) reflection across the y-axis

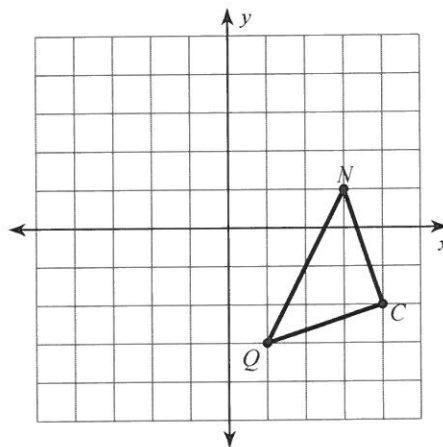

85) rotation 90° clockwise about the origin

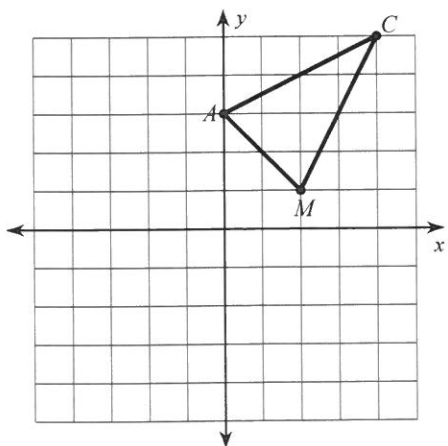

86) reflection across the x-axis

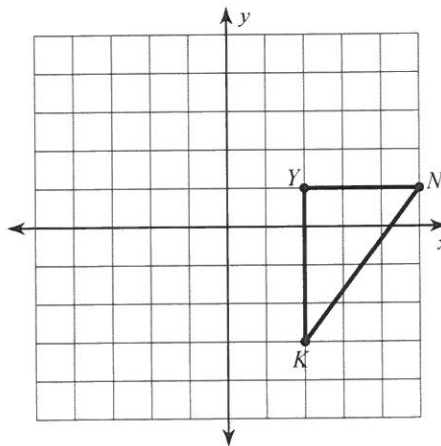

87) rotation 90° clockwise about the origin

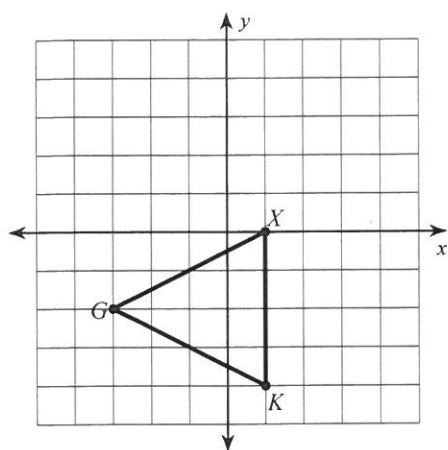

88) translation: 1 unit left and 1 unit up

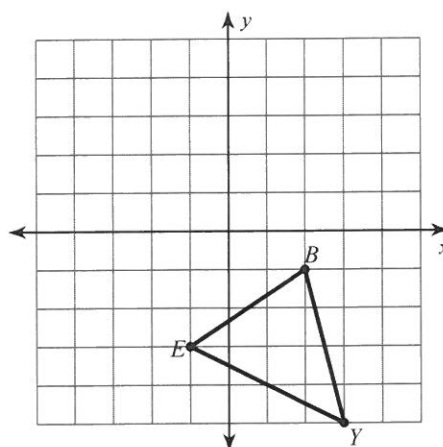

89) reflection across the y-axis

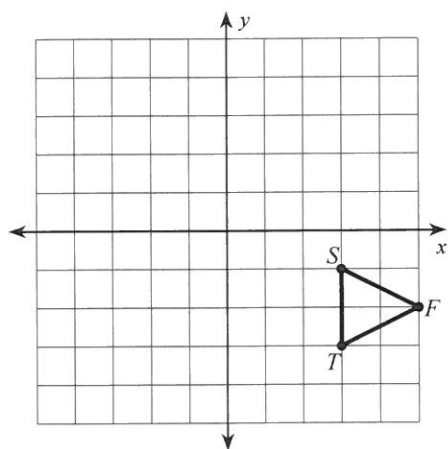

90) translation: 1 unit right and 2 units up

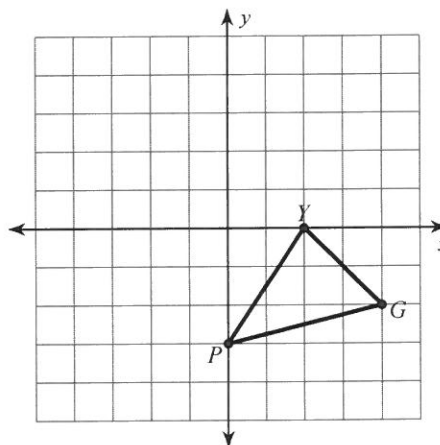

91) rotation 180° about the origin

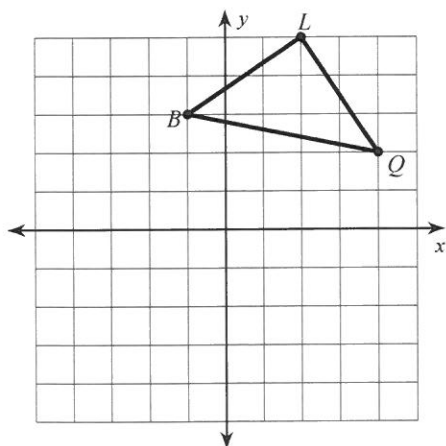

92) rotation 90° clockwise about the origin

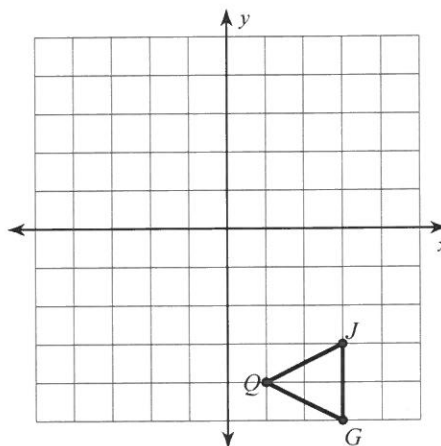

93) translation: 1 unit left and 3 units down

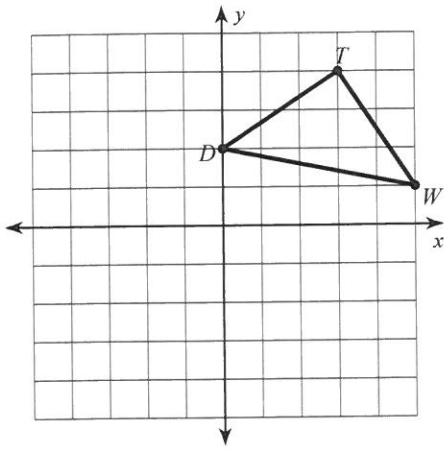

94) reflection across the x-axis

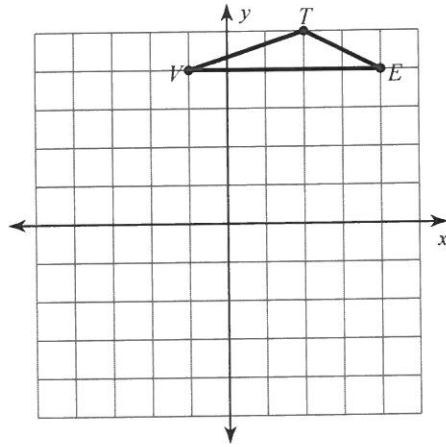

95) translation: 2 units down

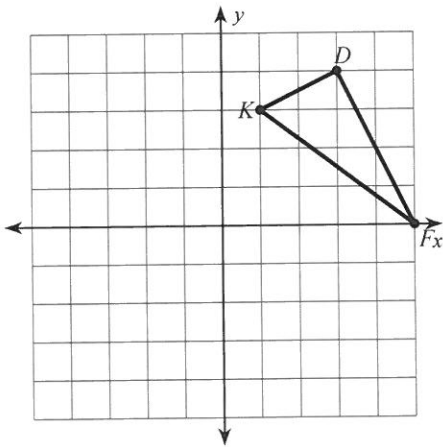

96) translation: 2 units left and 2 units down

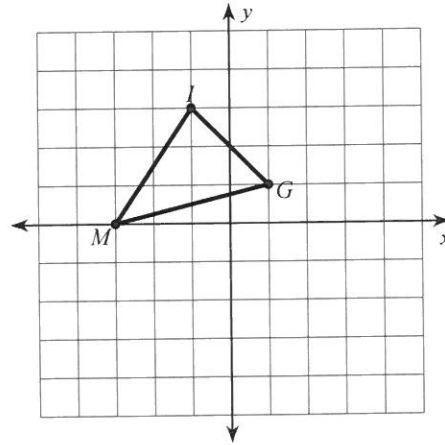

97) rotation 90° clockwise about the origin

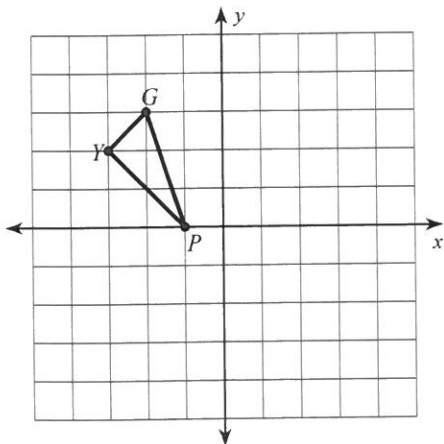

98) reflection across the x-axis

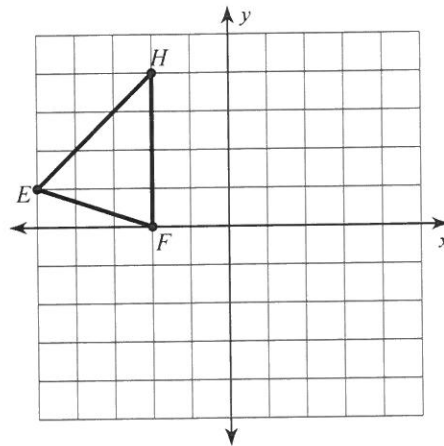

99) rotation 90° clockwise about the origin

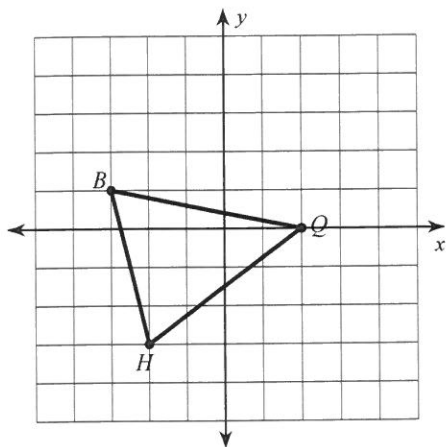

100) rotation 180° about the origin

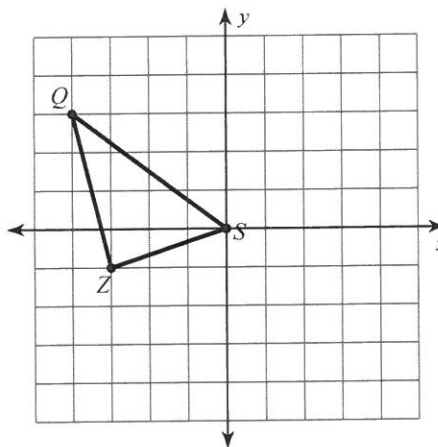

101) reflection across the x-axis

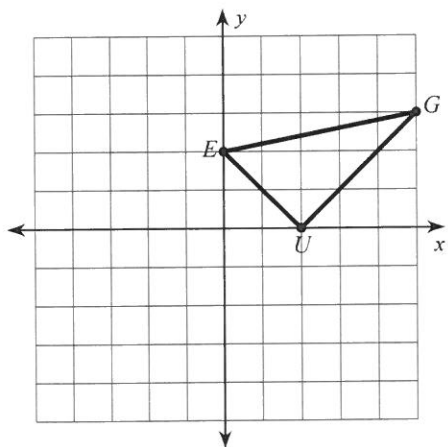

102) translation: 1 unit left and 1 unit down

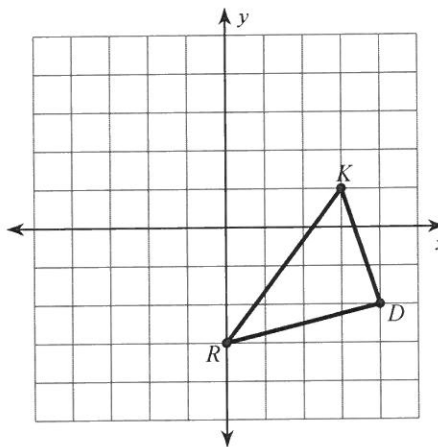

103) rotation 90° clockwise about the origin

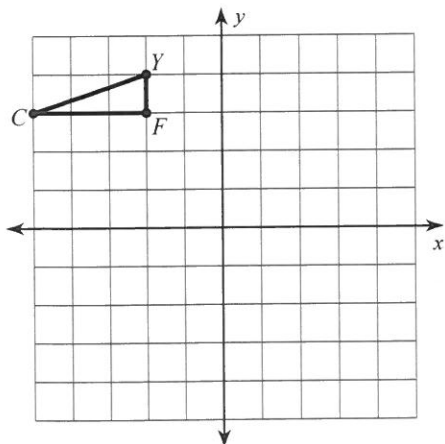

104) reflection across the x-axis

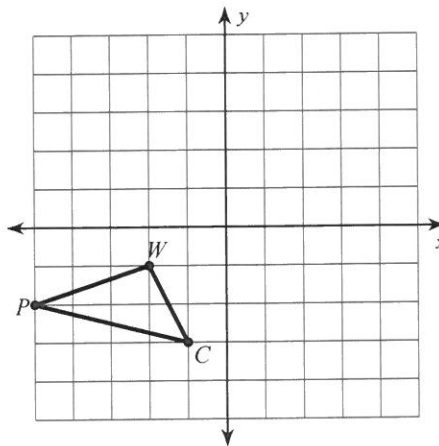

105) translation: 1 unit left and 1 unit down

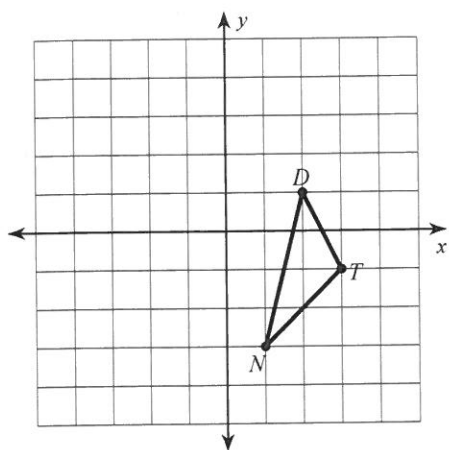

106) translation: 3 units right and 4 units down

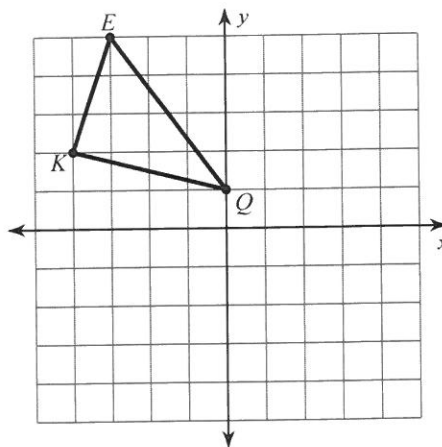

107) reflection across the y-axis

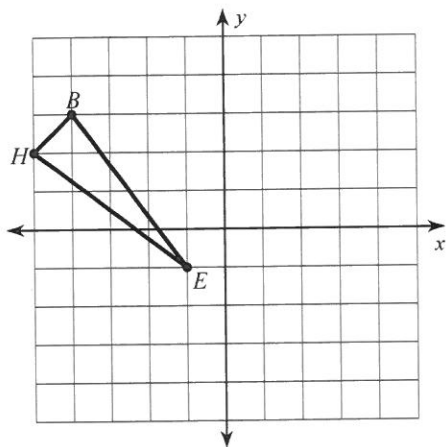

108) reflection across the x-axis

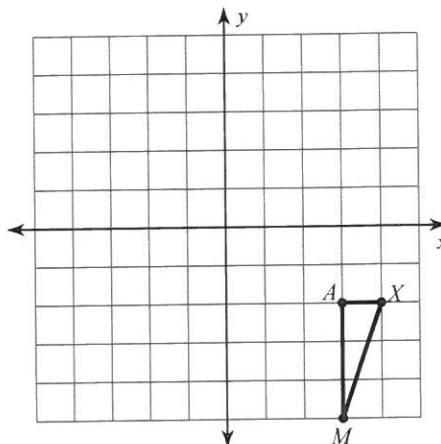

109) reflection across the y-axis

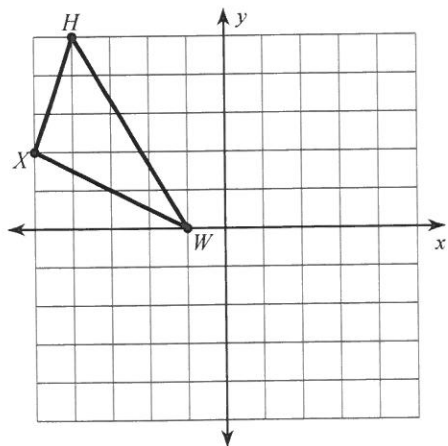

110) rotation 90° clockwise about the origin

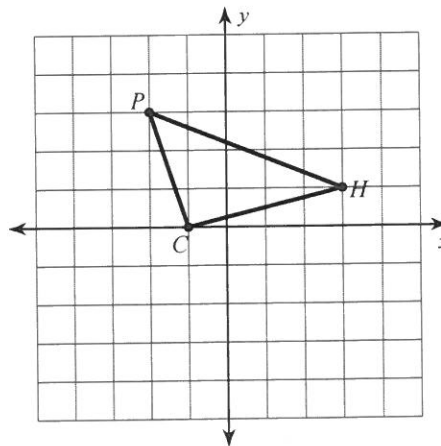

Determine whether each dashed line appears to be a line of symmetry.

111.

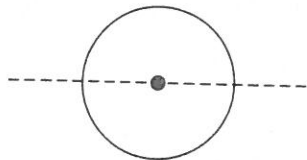

112.

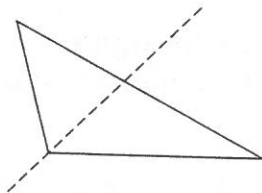

113.



Find all the lines of symmetry in each regular polygon.

114.

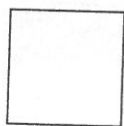

115.

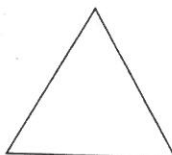

116.

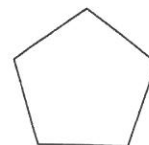

Draw each cut-out figure as it would look unfolded.

117.



118.

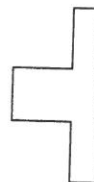

119. Draw a line of symmetry for the word

DID

120. How do you know if a figure has line symmetry?

Try to make a tessellation using each polygon.

121.

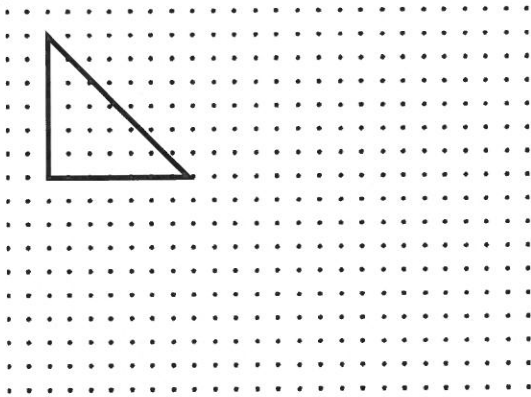

122.

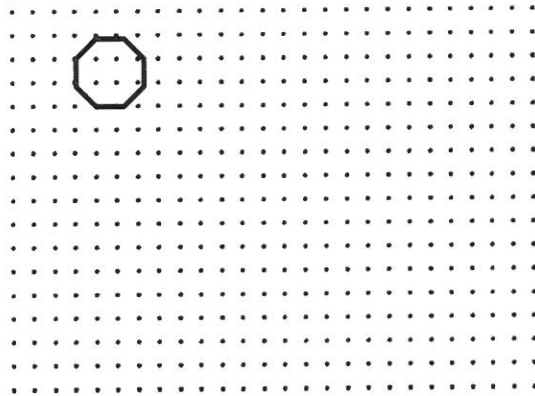

Tessellate each plane using the shapes given.

123. Squares and Octagons.

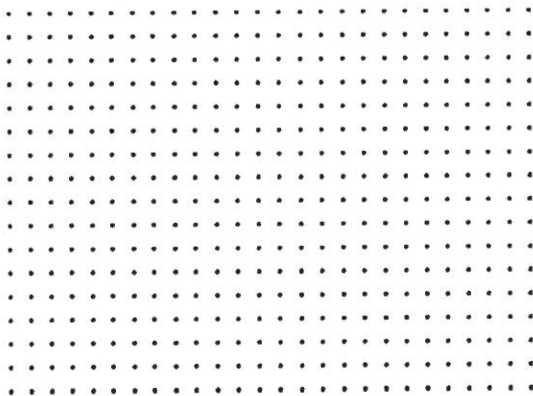

124. Triangles and Trapezoids.

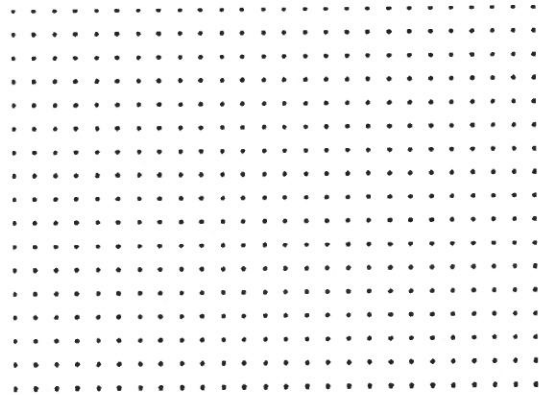

Answers to Study Guide Test 8 Graphing

- | | | | |
|--------------------------------------|-----------------|--|----------------|
| 1) not similar | 2) not similar | 3) not similar | 4) not similar |
| 5) similar | 6) similar | 7) similar | 8) not similar |
| 9) not similar | 10) not similar | 11) 6 | 12) 25 |
| 13) 16 | 14) 24 | 15) 18 | 16) 16 |
| 17) 10 | 18) 15 | 19) 6 | 20) 40 |
| 21) 16 | 22) 16 | 23) 30 | 24) 35 |
| 25) 24 | 26) 30 | 27) 24 | 28) 25 |
| 29) 6 | 30) 12 | 31) not similar | 32) similar |
| 33) similar | 34) not similar | 35) not similar | 36) similar |
| 37) not similar | 38) similar | 39) not similar | 40) similar |
| 41) 70 | 42) 9 | 43) 13 | 44) 36 |
| 45) 8 | 46) 14 | 47) 20 | 48) 132 |
| 49) 56 | 50) 32 | 51) 70 | 52) 99 |
| 53) 10 | 54) 48 | 55) 144 | 56) 33 |
| 57) 130 | 58) 49 | 59) 98 | 60) 6 |
| 61) $M(2, 8)$ $L(8, -7)$ $K(-6, 3)$ | | 62) $E(-9, 8)$ $F(0, 6)$ $G(-6, -2)$ | |
| $J(-5, -9)$ $I(-9, 4)$ $H(0, -8)$ | | $H(1, 10)$ $I(10, 1)$ $J(-6, -5)$ | |
| $G(9, 9)$ $F(0, -4)$ $E(-1, 1)$ | | $K(0, 1)$ $L(-1, 9)$ $M(5, 7)$ | |
| $D(10, -4)$ | | $N(-7, -4)$ | |
| 63) $C(-3, 4)$ $D(6, -5)$ $E(10, 4)$ | | 64) $C(7, -8)$ $D(-7, -9)$ $E(-8, -9)$ | |
| $F(-6, -1)$ $G(3, 0)$ $H(-7, 7)$ | | $F(-4, 2)$ $G(6, 9)$ $H(4, -9)$ | |
| $I(6, 2)$ $J(-4, -7)$ $K(4, 3)$ | | $I(8, 6)$ $J(-7, -8)$ $K(-4, 1)$ | |
| $L(0, 9)$ | | $L(-9, 1)$ | |
| 65) $J(6, -4)$ $I(6, -5)$ $H(5, -4)$ | | 66) | |
| $G(-2, 2)$ $F(5, 5)$ $E(9, -1)$ | | | |
| $D(9, 7)$ $C(-10, -5)$ $B(0, -8)$ | | | |
| $A(-8, 1)$ | | | |

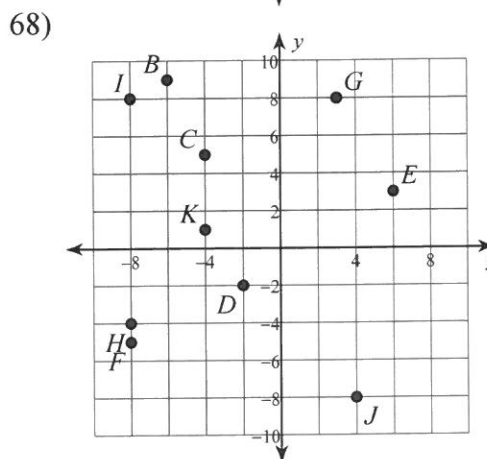
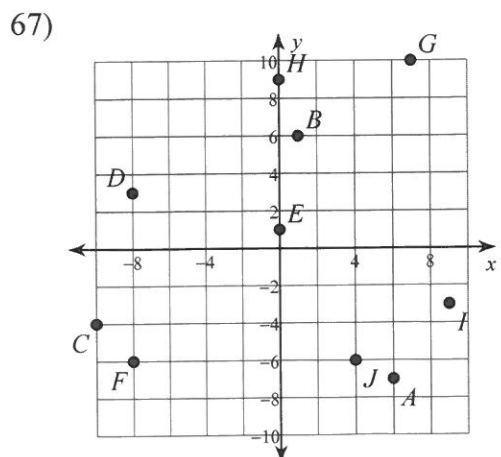
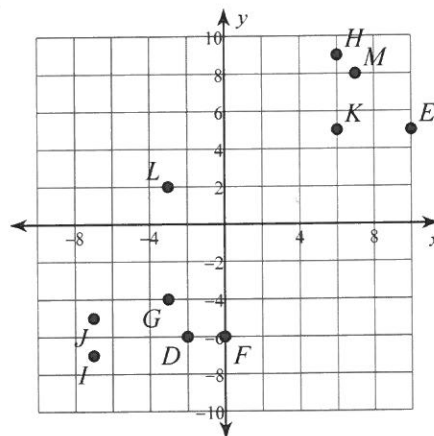

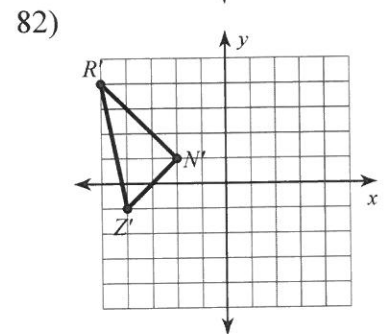
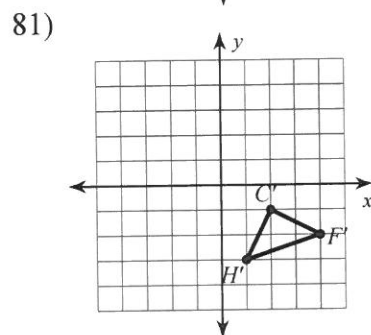
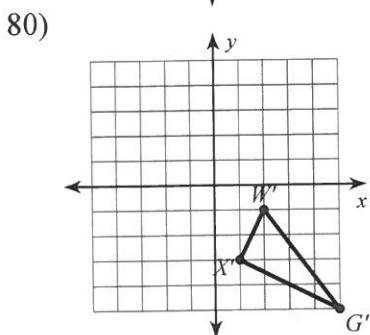
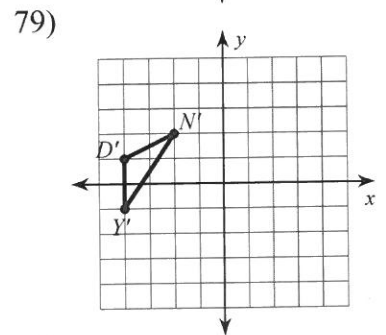
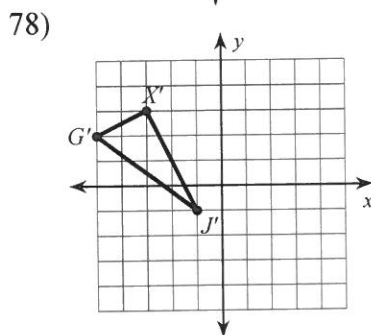
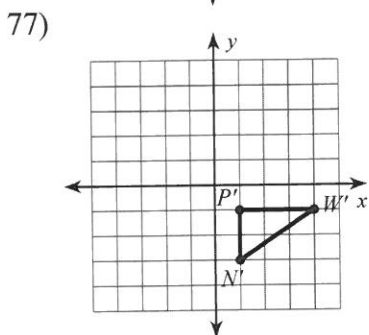
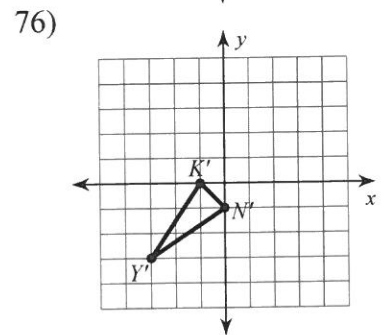
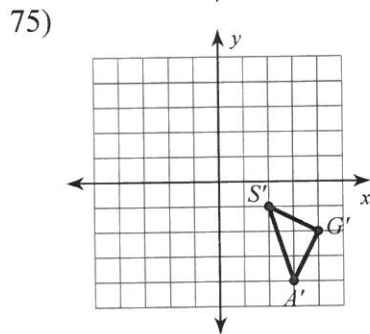
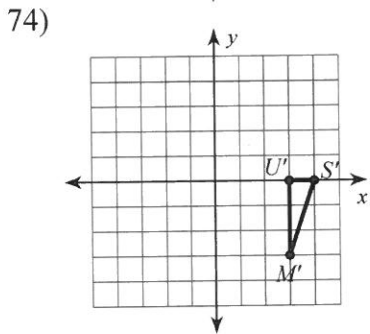
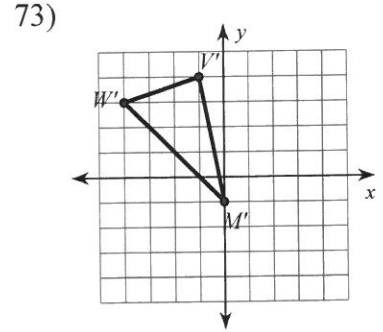
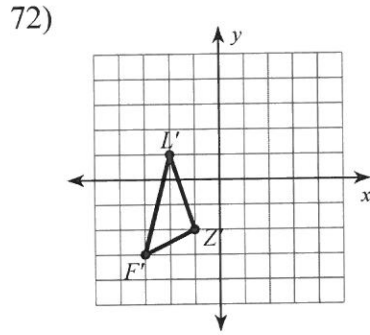
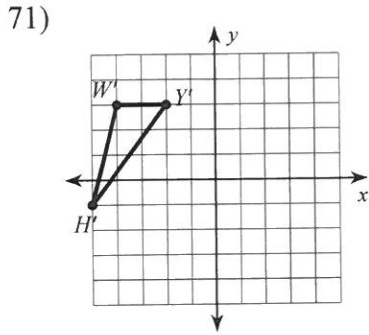
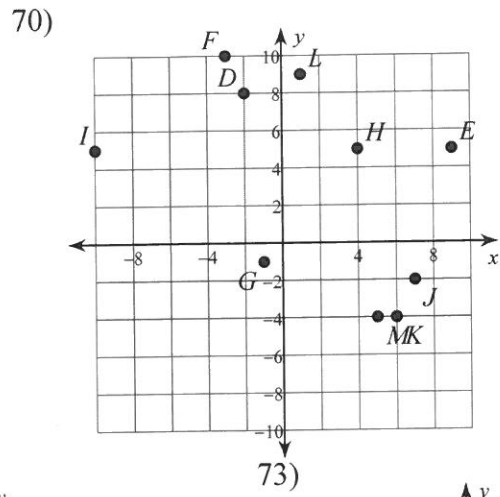
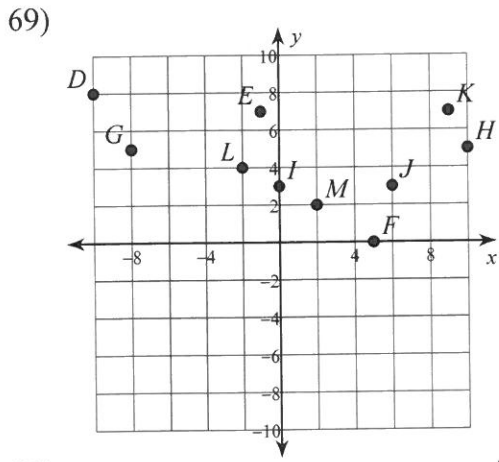

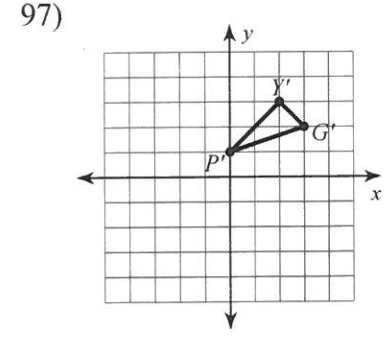
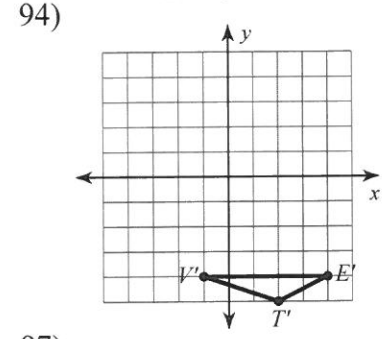
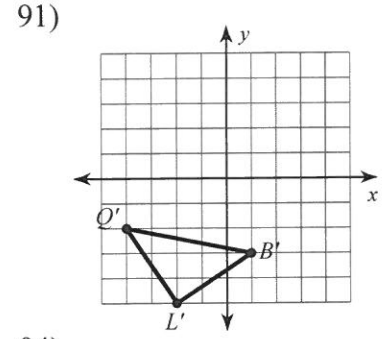
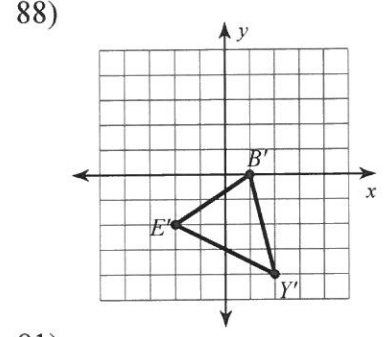
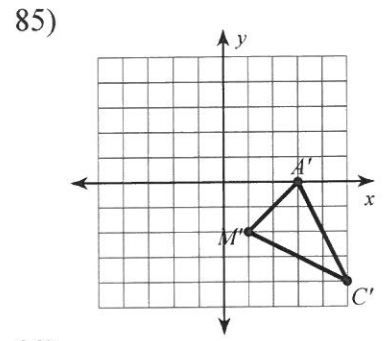
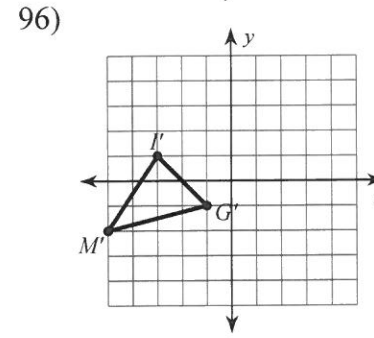
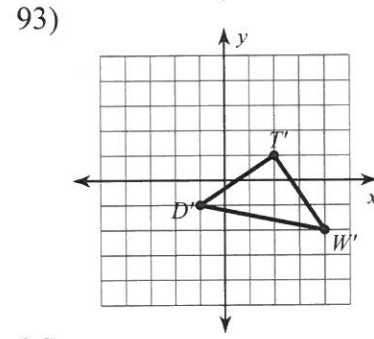
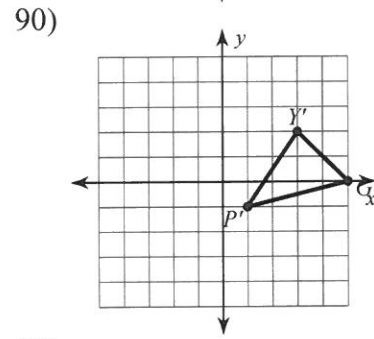
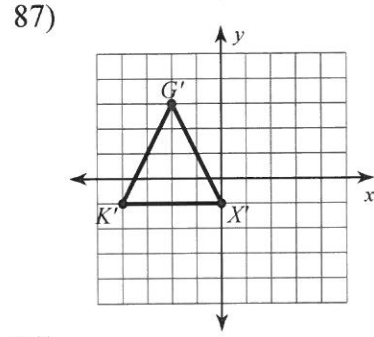
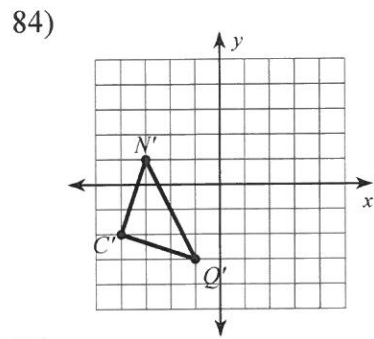
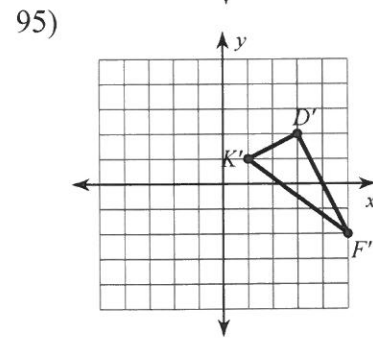
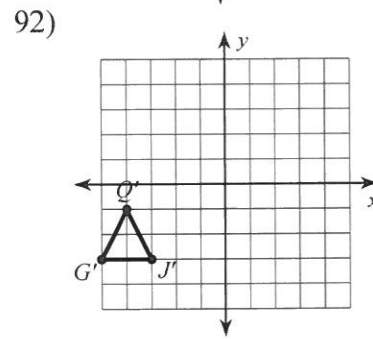
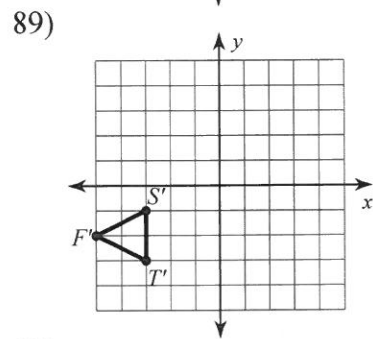
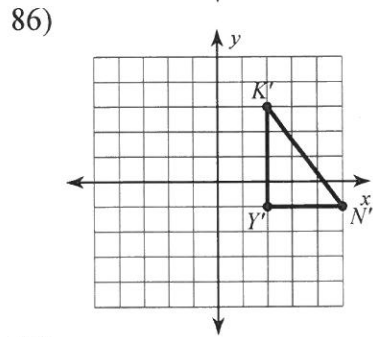
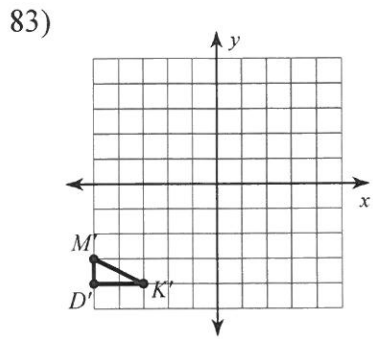

98)

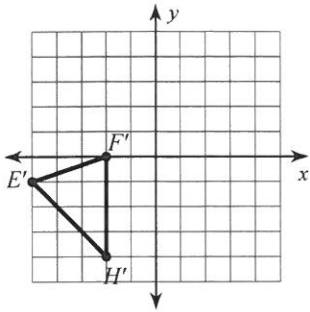

99)

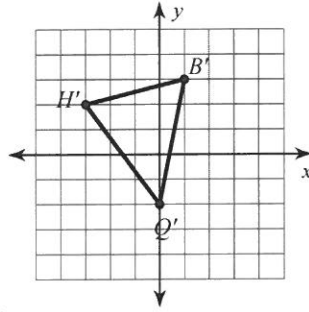

100)

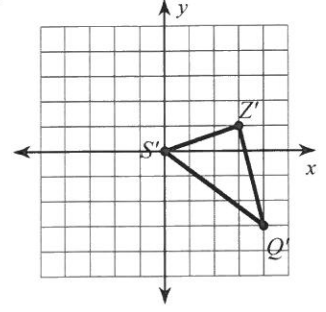

101)

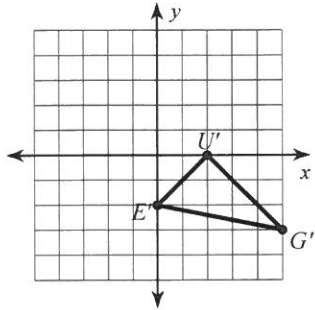

102)

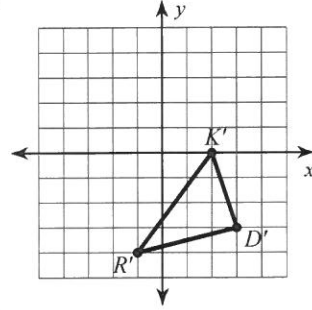

103)

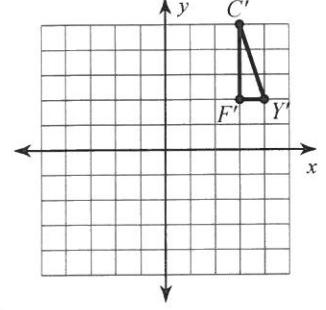

104)

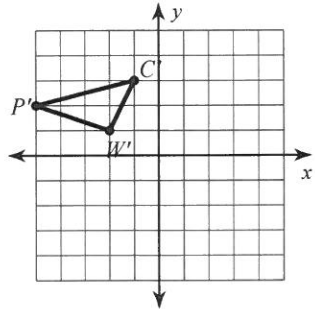

105)

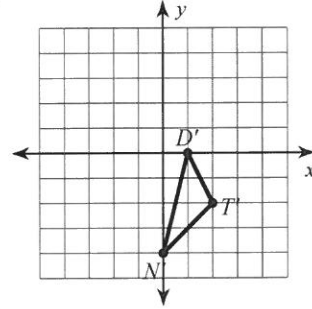

106)

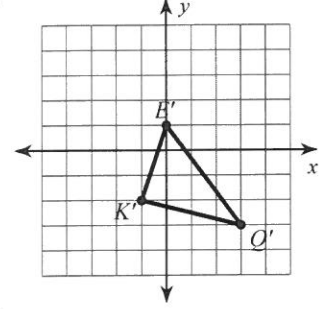

107)

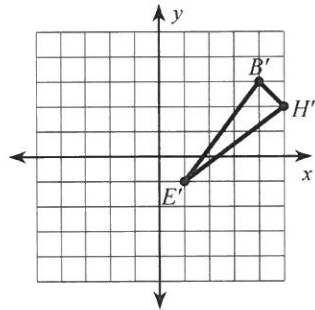

108)

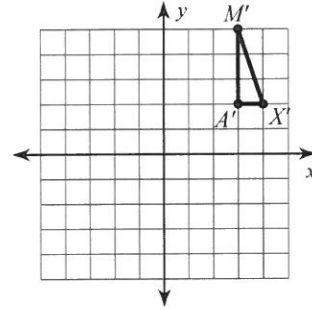

109)

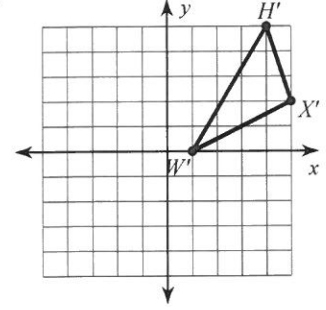

110)

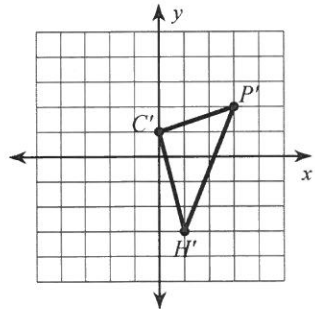

Determine whether each dashed line appears to be a line of symmetry.

111.

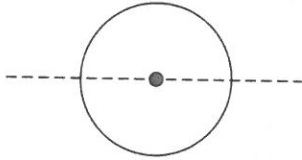

it is a line of symmetry

112.

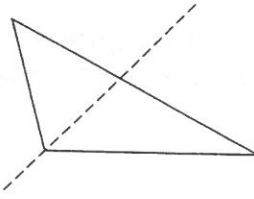

it is not a line of symmetry

113.



it is a line of symmetry

Find all the lines of symmetry in each regular polygon.

114.

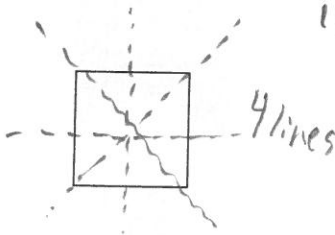

4 lines

115.

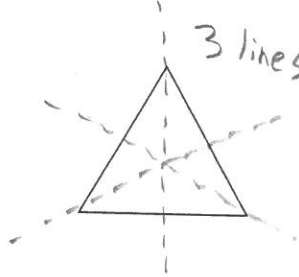

3 lines

116.



5 lines

Draw each cut-out figure as it would look unfolded.

117.

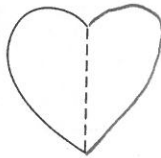

118.

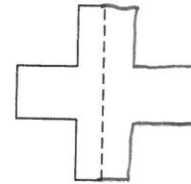

119. Draw a line of symmetry for the word



120. How do you know if a figure has line symmetry?

If you can fold the figure in half and the two parts are the exact same it has line symmetry.

Try to make a tessellation using each polygon.

121.

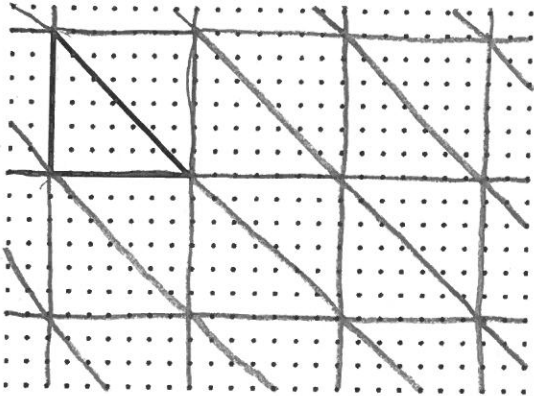

122.

can't be made into a tessellation

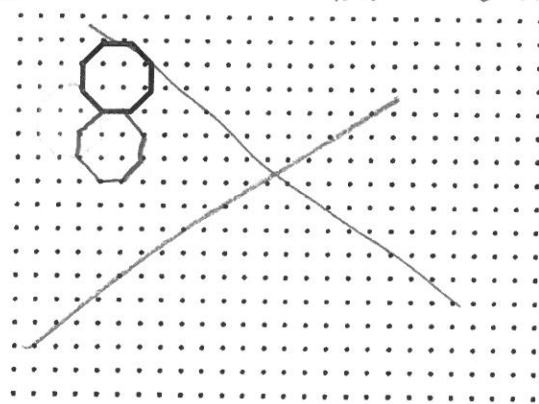

Tessellate each plane using the shapes given.

123. Squares and Octagons.

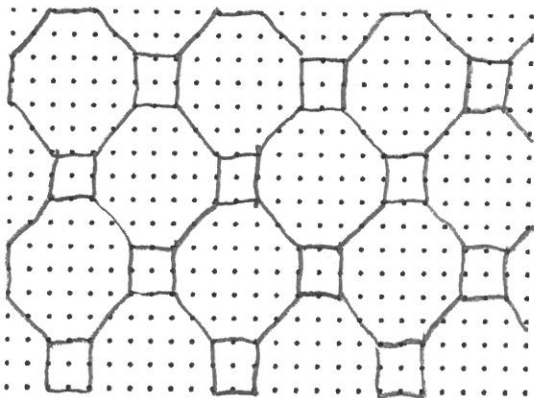

124. Triangles and Trapezoids.

